

16 characters x 2 lines + white LED backlight

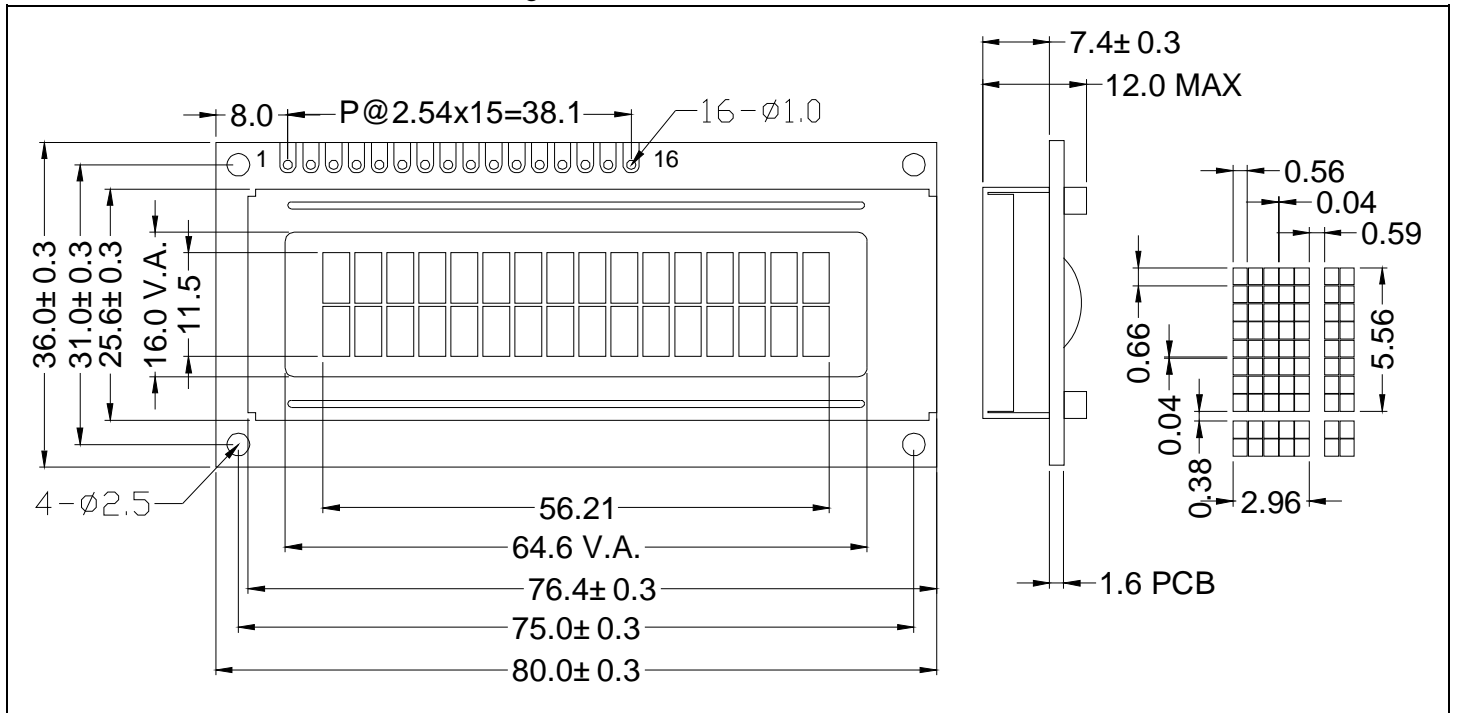

ABSOLUTE MAXIMUM RATINGS

Item	Symbol	Min.	Max.	Unit
Supply Voltage(Logic)	VDD-VSS	-0.3	7.0	V
Supply Voltage(LCD)	VDD-VO	-0.3	13.0	V
Input Voltage	VI	-0.3	VDD+0.3	V
Operating Temp.	Topr	-20	70	°C
Storage Temp.	Tstg	-30	80	°C

MECHANICAL DATA

Item	Nominal Dimensions	Unit
Module Size(W x H x T)	80.0 x 36.0 x 12.0	mm
Viewing Area(W x H)	64.6 x 16.0	mm
Character Size (W x H)	2.96 x 5.56	mm
Dot Size (W x H)	0.56 x 0.66	mm
Weight	Approx. 36	g

ELECTRICAL CHARACTERISTICS (VDD=5V±5%)

Item	Symbol	TEST Condition	Min.	Typ.	Max.	Unit
Input High Voltage	VIH	--	2.2	--	VDD	V
Input Low Voltage	VIL	--	-0.3	--	0.6	V
Output High Voltage	VOH	IOH=-0.2mA	2.4	--	VDD	V
Output Low Voltage	VOL	IOL=1.2mA	0	--	0.4	V
Supply Current	IDD	VDD=5.0V	--	1.5	3.0	mA
LCD Driving Voltage	VDD-VO	Ta=25°C	--	4.6	--	V

PIN CONNECTIONS

PIN	Symbol	Level	Function
1	VSS	0V	GND
2	VDD	+5V	Power supply for logic
3	Vo	--	Contrast adjusting
4	RS	H/L	H:Data L:Instruction code
5	R/W	H/L	H:Read L:Write
6	E	H,H→L	Enable signal
7	DB0	H/L	Data bus line
8	DB1	H/L	
9	DB2	H/L	
10	DB3	H/L	
11	DB4	H/L	
12	DB5	H/L	
13	DB6	H/L	
14	DB7	H/L	Power supply for LED backlight
15	LED+	5V	
16	LED-	0V	

BLOCK DIAGRAM

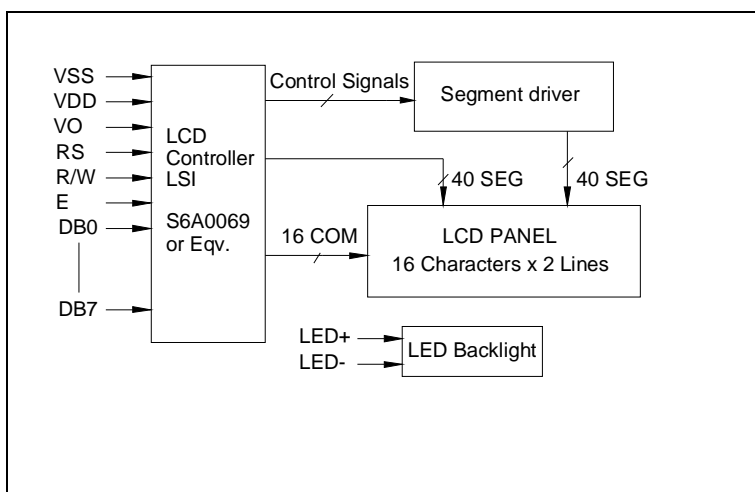

LED BACKLIGHT SPECIFICATIONS(Ta=25°C)

Item	Symbol	Typ.	Max.	Unit
Forward Voltage	Vf	3.1	3.3	V
Forward Current	If	30	--	mA
LED Color		White		